

PLANIMETRIA GENERALE scala 1:2000

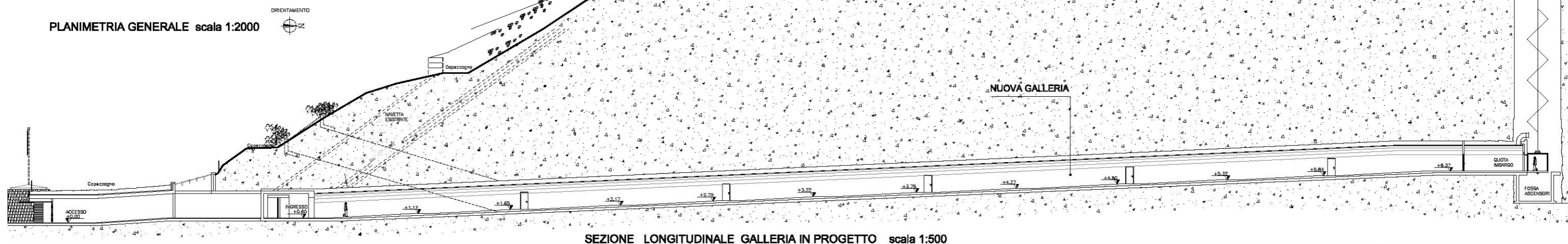

SEZIONE LONGITUDINALE GALLERIA IN PROGETTO scala 1:500

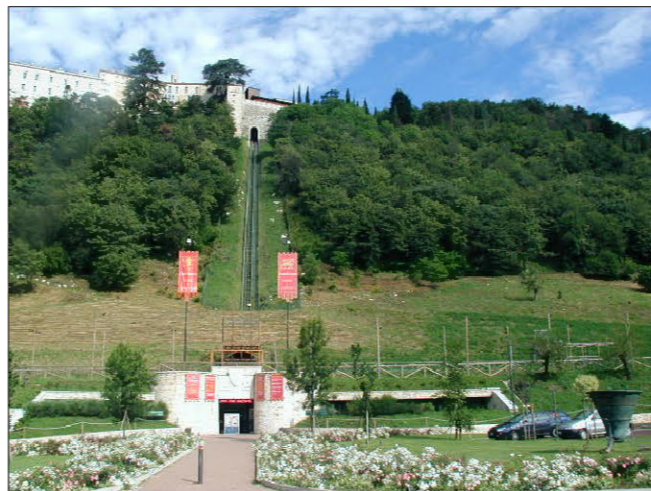
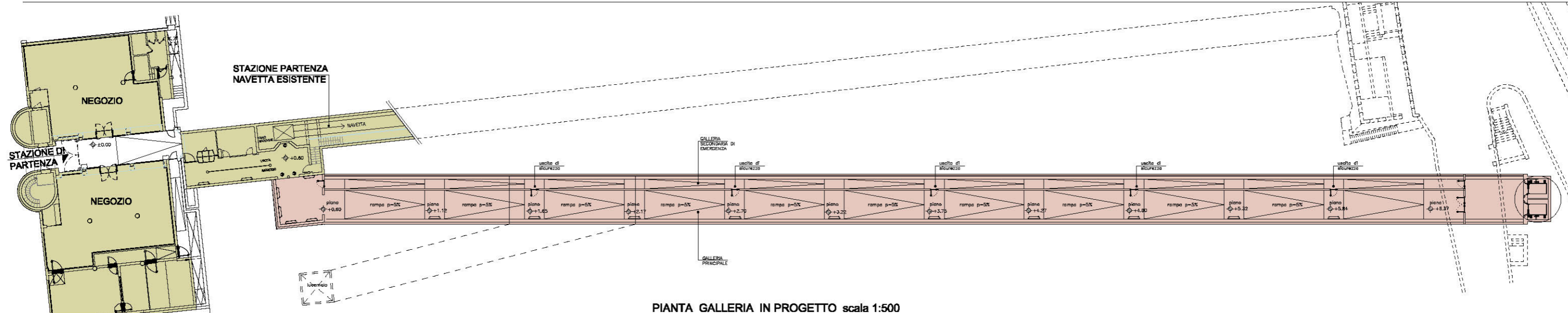

PIANTA GALLERIA IN PROGETTO scala 1:500

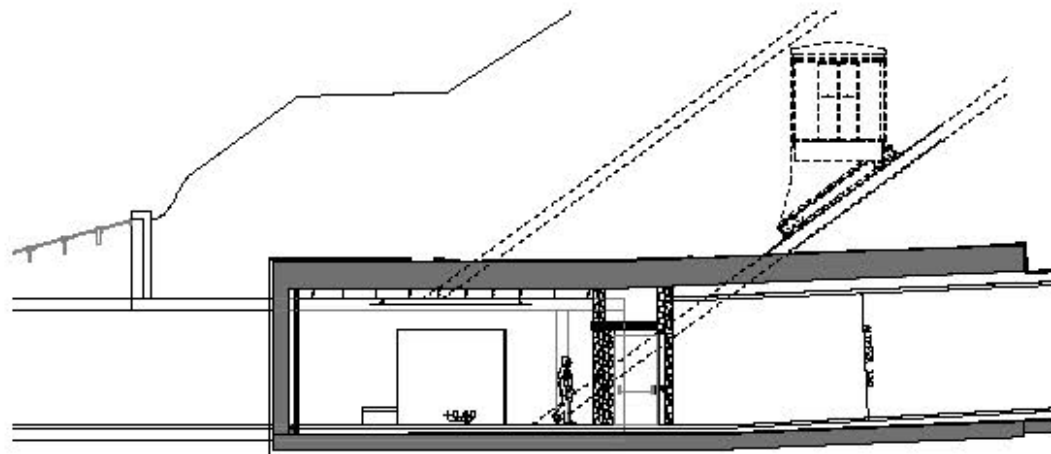

PARTICOLARE SEZIONE INGRESSO scala 1:200

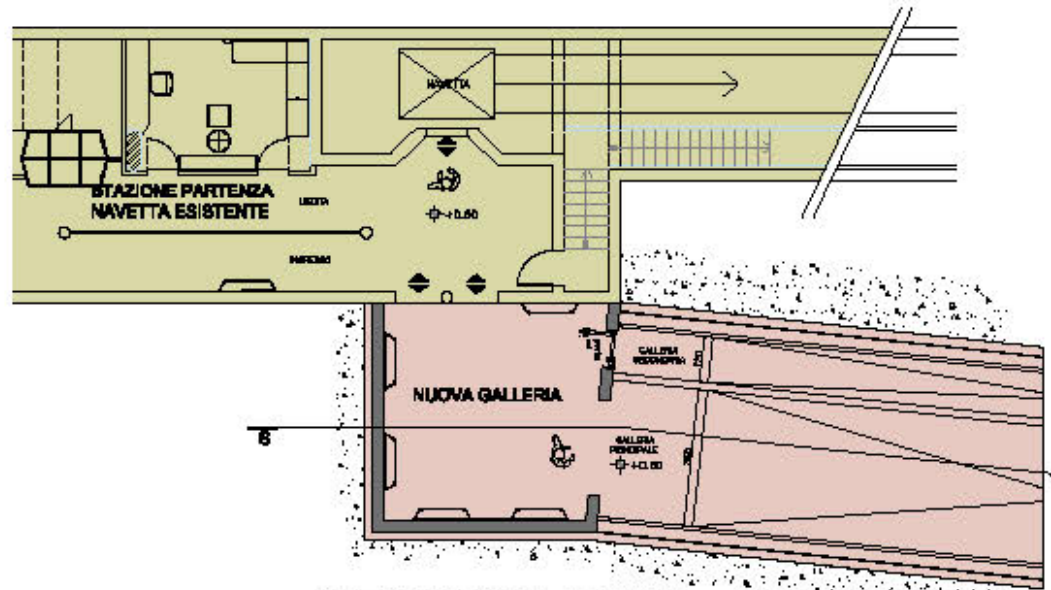

PARTICOLARE PIANTE INGRESSO scala 1:200

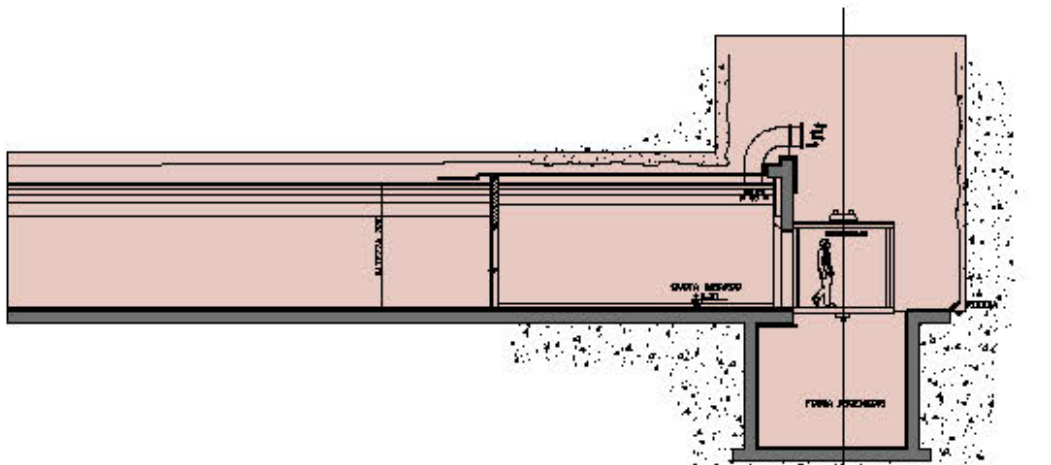

PARTICOLARE SEZIONE IMBARCO scala 1:200

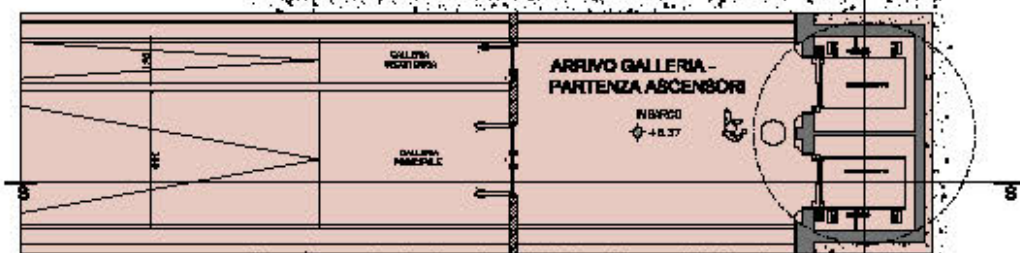

PARTICOLARE PIANTE IMBARCO scala 1:200

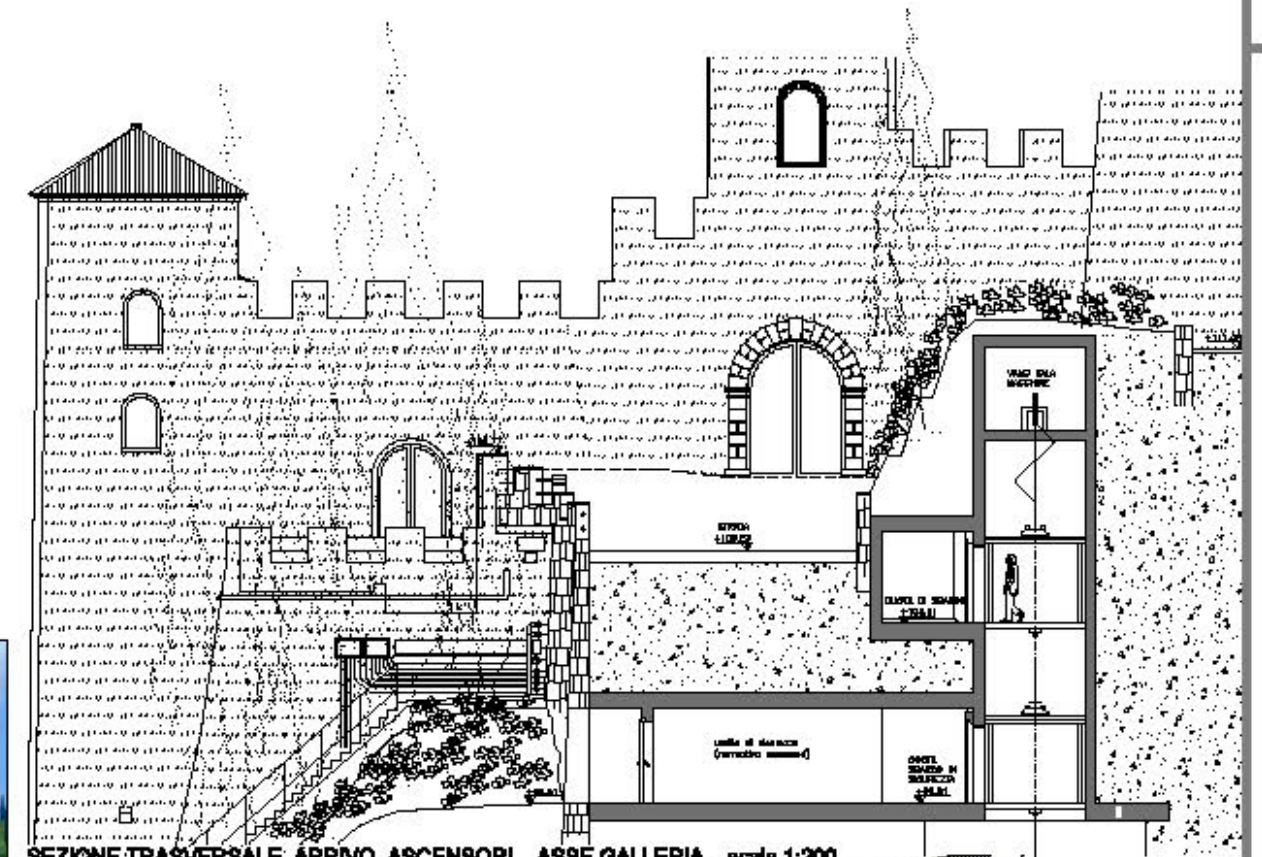

SEZIONE TRASVERSALE ARRIVO ASCENSORI ASSE GALLERIA scala 1:200

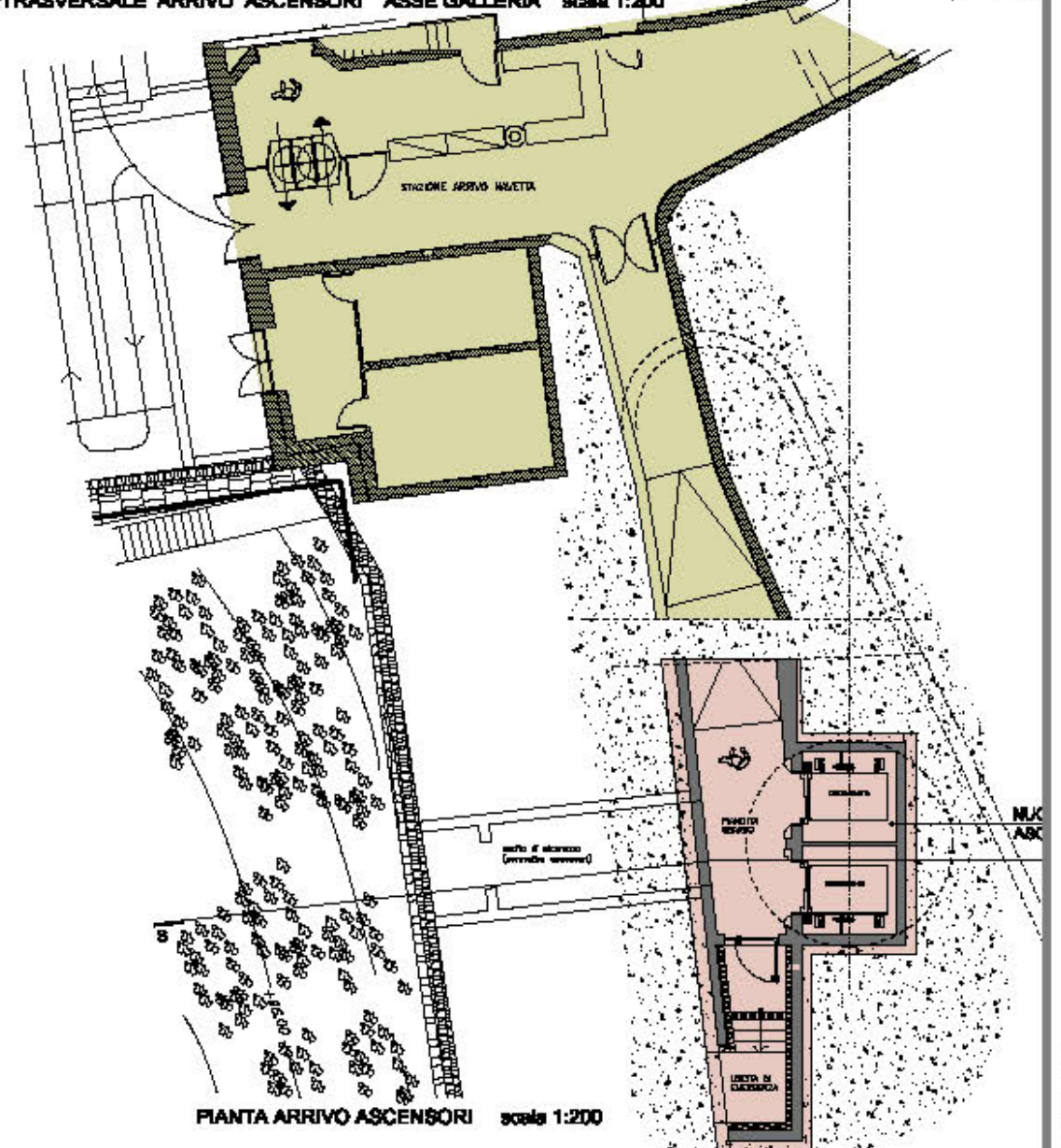

PIANTA ARRIVO ASCENSORI scala 1:200



SCHIZZO DI PROGETTO

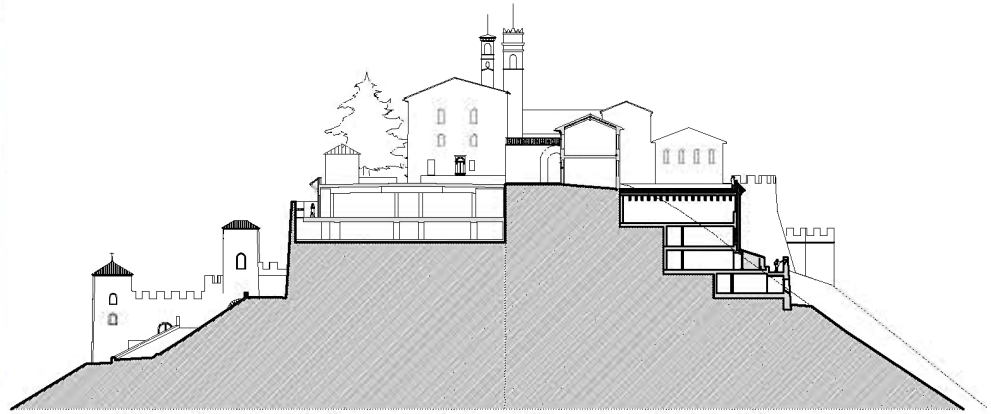

SEZIONE JUNIOR SUITES OVEST

60 JUNIOR SUITES OVEST    M<sup>2</sup> 2.690    M<sup>3</sup> 8.720

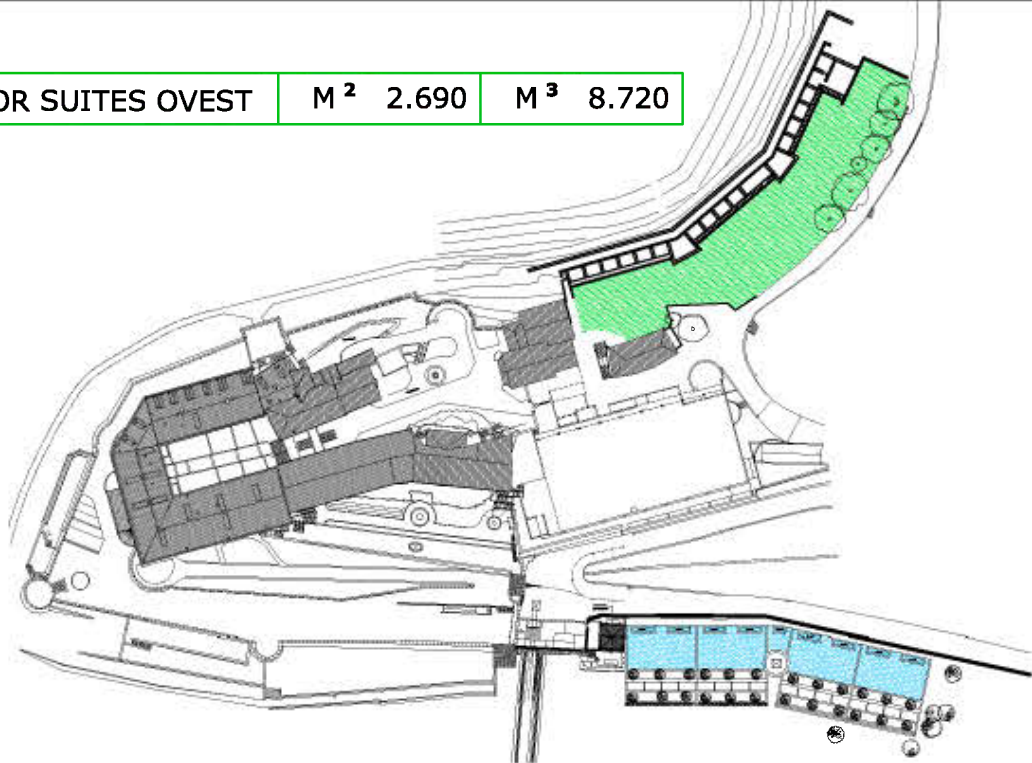

60 JUNIOR SUITES EST    M<sup>2</sup> 2.690    M<sup>3</sup> 8.720

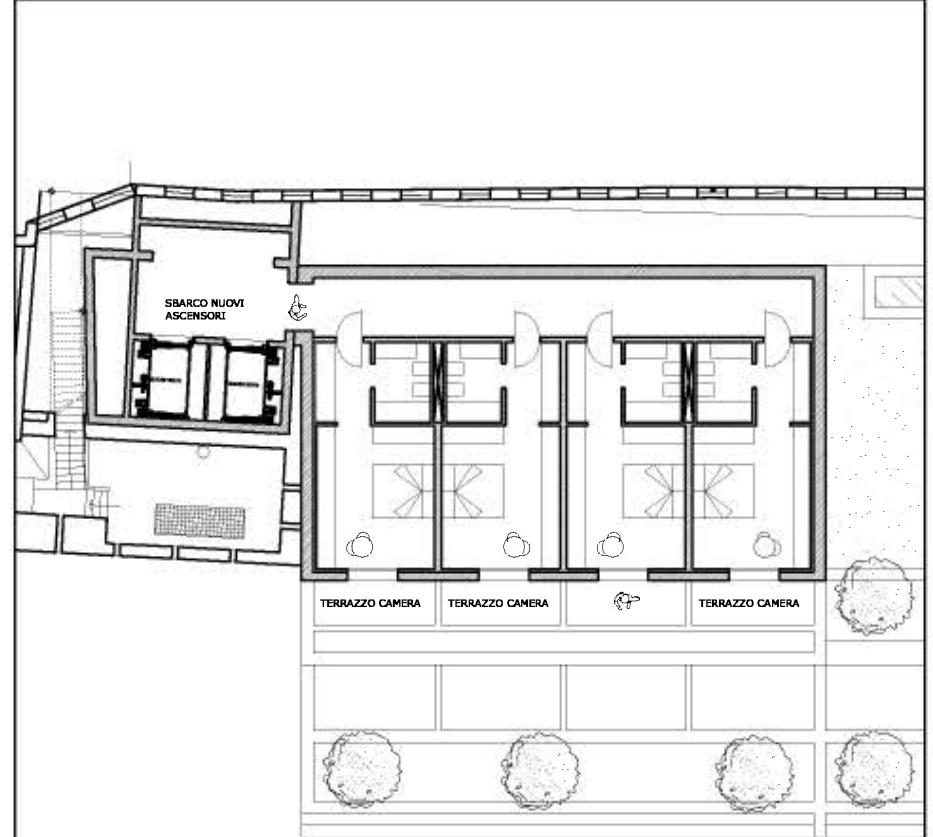

CAMERE TIPO

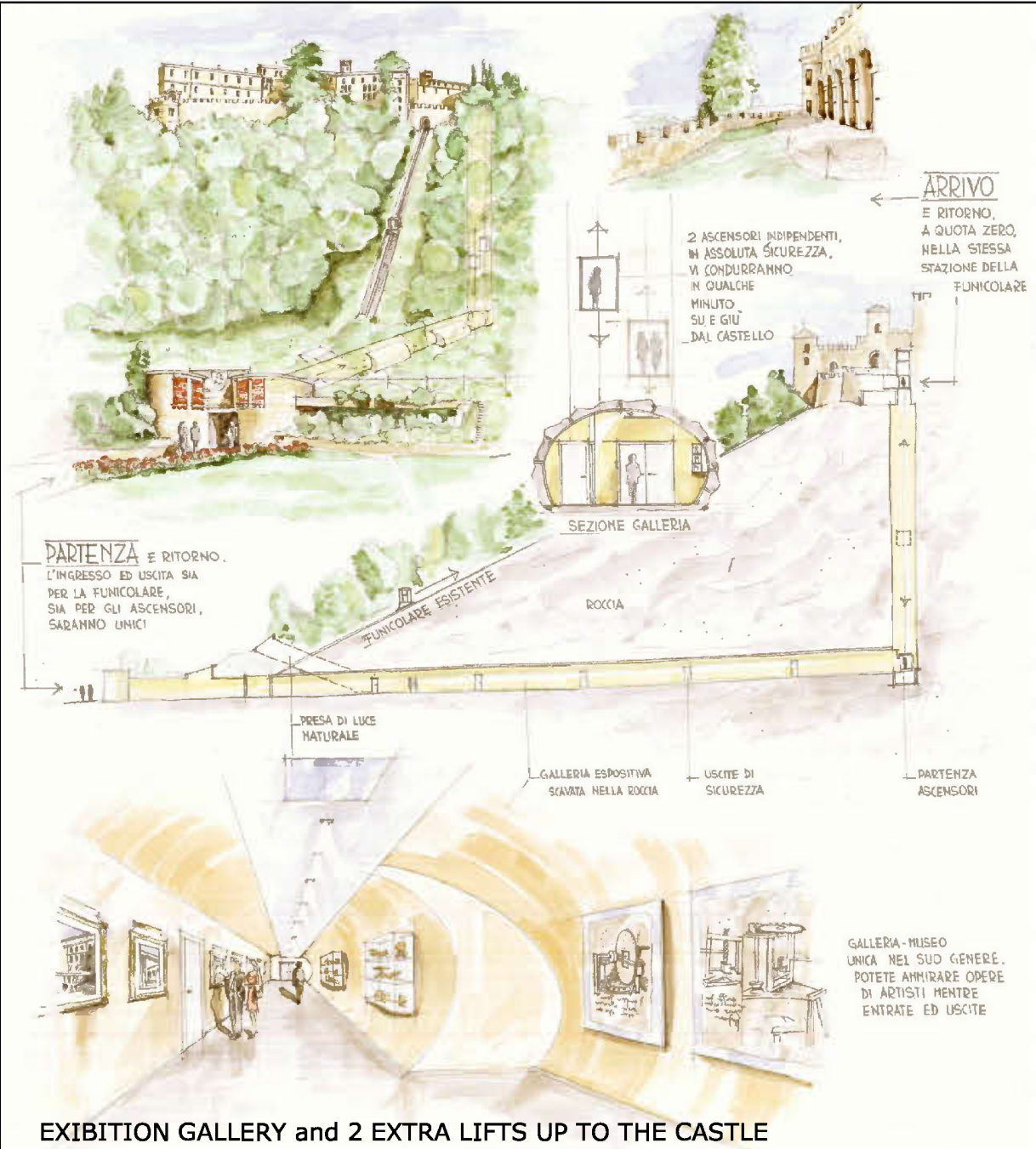

EXIBITION GALLERY and 2 EXTRA LIFTS UP TO THE CASTLE

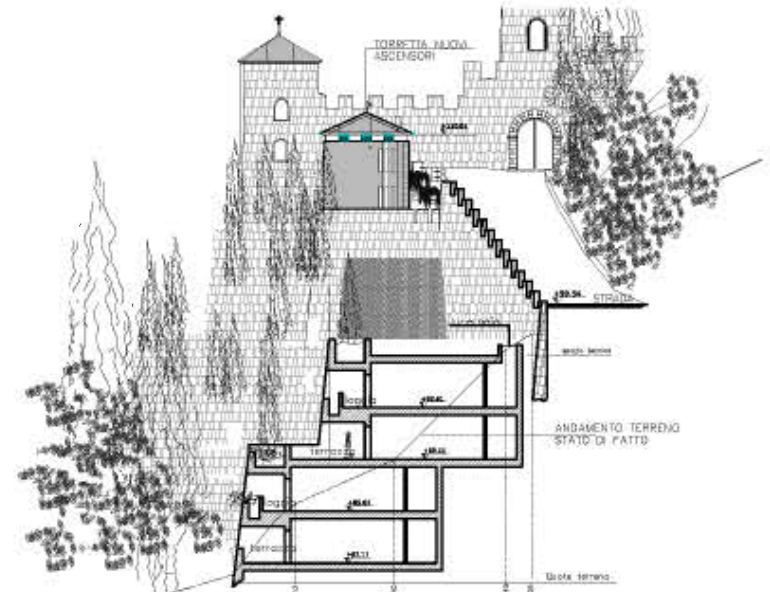

SEZIONE JUNIOR SUITES EST

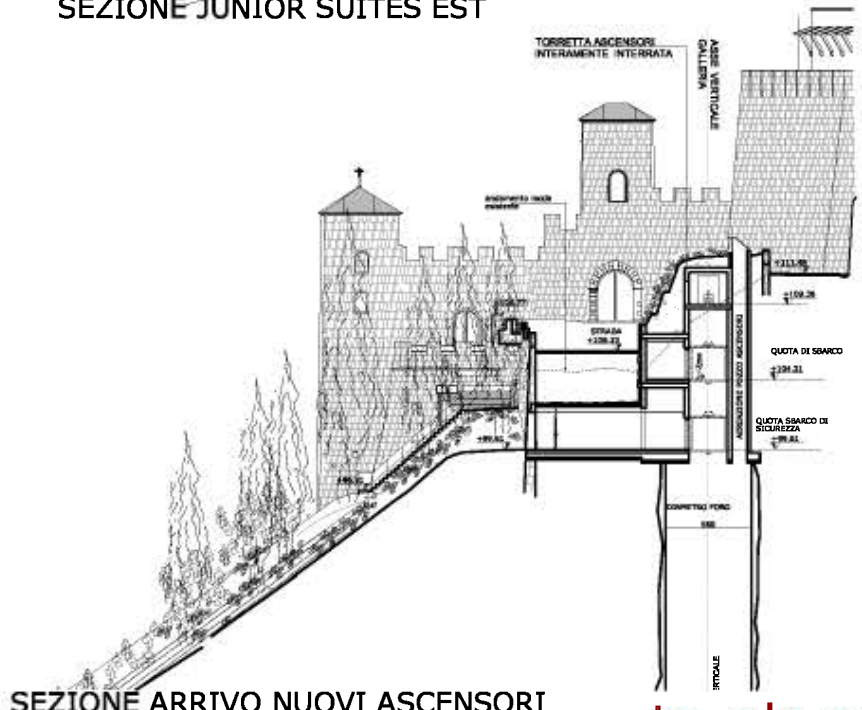

SEZIONE ARRIVO NUOVI ASCENSORI